

# Aloha mai

**As you wait for our papa to begin, we invite you to do the following**

1

Clear your mind of things happening around you that are distracting you from getting the most out of this experience.

2

Take some deep breaths!

3

Exhale any stress, negativity, worries or anger and inhale pure, pono air.



**EA E-LEARNING**  
**HO‘OMĀKAUKAU ‘AI**  
**Food Preparation**  
**Pule #5**





**KUMU:**

**‘Anakē Kū Kahakalau**

**PAPAĀHANA:**

**KAU‘ELI‘ELI**



## HOUSEKEEPING

- Rename ZOOM: ‘Ohana \_\_\_\_\_
- Mute your microphone unless you are speaking to all.
- Keep your camera on - unless internet is very poor.
- Participate in all activities
- Remember, the more you talk Hawaiian, the better you will sound.....



## **ALOHA E** (Greeting Chant)

*Nā Nālei and Kū Kahakalau*

**Aloha e**

*Greetings*

**Aloha e nā akua**

*Greetings deities*

**Aloha e nā ‘aumākua**

*Greeting ancestors*

**Aloha e nā ali’i o Hawai‘i**

*Greetings to the chiefs of Hawai‘i*

**Aloha e nā kūpuna**

*Greetings elders*

**Aloha e nā mākua**

*Greetings adults*

**Aloha e ka lehulehu**

*Greetings to the multitudes*

**Aloha e**

*Greetings*



## E HŌ MAI (Centering Chant)

*Nā Edith Kanaka 'ole*

**E hō mai i ka 'ike mai luna mai e**

**'O nā mea huna no'eau o nā mele e**

**E hō mai, e hō mai, e hō mai e**

*Grant us knowledge from above*

*About the wisdom hidden in the chants*

*Grant it, grant it, grant it.*

**HANU MAI I KA PONO**

**HANU AKU I NĀ MEA PONO 'OLE**







**‘O Kū Hinahinakūikahakai  
Kahakalau ko‘u inoa.**





**‘O Honolulu  
ku‘u one hānau.**



**KŪ-A-KANAKA**

**[www.kuakanaka.com](http://www.kuakanaka.com)**

**When Natives Thrive Everyone Benefits**



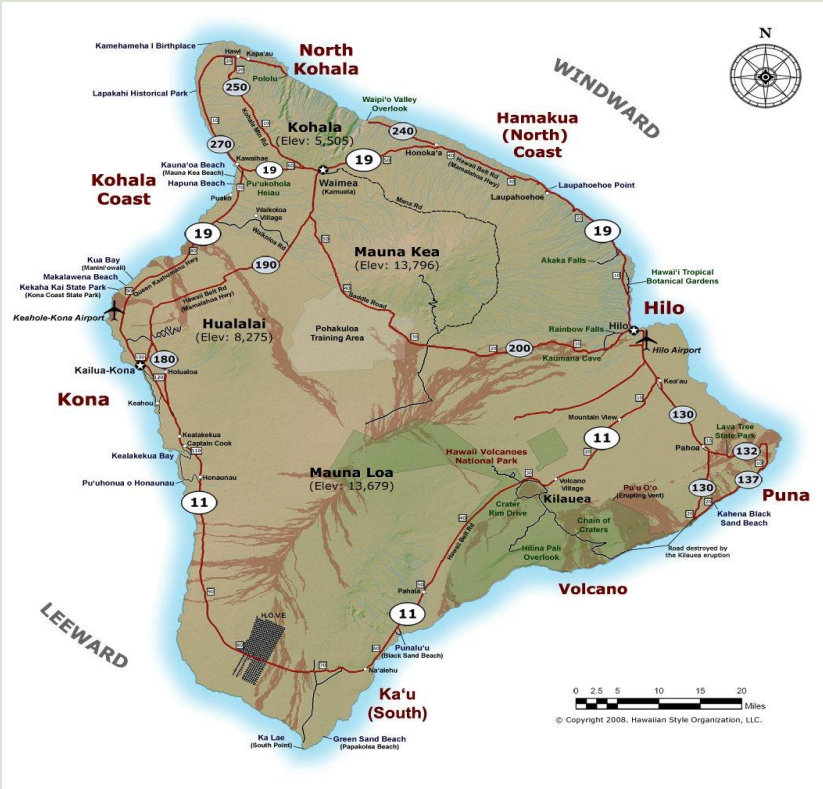

‘O Hawai‘i ku‘u mokupuni.





**‘O Hāmākua ku‘u moku.**



**KŪ-A-KANAKA**

**[www.kuakanaka.com](http://www.kuakanaka.com)**

**When Natives Thrive Everyone Benefits**



**‘O Kīlauea ku‘u mauna.**



**KŪ-A-KANAKA**

**[www.kuakanaka.com](http://www.kuakanaka.com)**

**When Natives Thrive Everyone Benefits**



**‘O Makua ku‘u kai.**



**KŪ-A-KANAKA**

**[www.kuakanaka.com](http://www.kuakanaka.com)**

**When Natives Thrive Everyone Benefits**





**‘O Waipi‘o ku‘u awāwa.**



**KŪ-A-KANAKA**

**[www.kuakanaka.com](http://www.kuakanaka.com)**

**When Natives Thrive Everyone Benefits**



# KU'U MO'OKŪ'AUHAU

**Daniela  
Kekino  
Kahakalau**

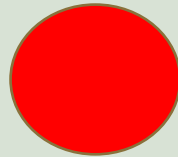
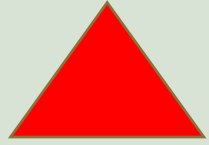

**Keao  
Opupele**

**William  
Keahonui  
Kahakalau**

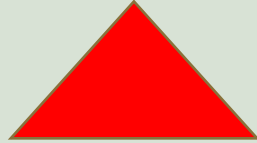

**Irene  
Dow**

**Robert A.  
Kahakalau**

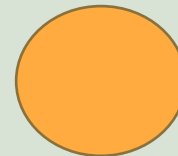
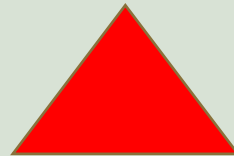

**Frieda B.  
Schmidt**

**Kū Hinahinakūikahakai Kahakalau**



## CHILD

- Keiki
  - Kama
  - Mamo
  - Lei
  - Pua
  - Liko
  - ‘Ōpu‘u/Hāpu‘u/Nōpu‘u (Ni‘ihau)
  - Hānau
  - Poke‘o
- } Kamali‘i - little child (toddler)  
Kamaiki - tiny child (baby, infant)
- Kama-pua‘a
- Kama-lālā-walu (Maui Chief)



# KAMA A \_\_\_\_\_

Kīhā-a-Pi‘ilani

‘Umi-a-Līloa

Kapu-kini-a-Liloa

Keawe-a-Heulu

Keawe-nui-a-‘Umi

Kamola-nui-a-‘Umi

Alapa‘i-nui-a-Kauaua

Ka-uhi-a-Kama

Ka-welo-a-Aila



# KU‘U MO‘OKŪ‘AUHAU

‘O (w)au ‘o \_\_\_\_\_

Keiki a \_\_\_\_\_ . (parent)

Keiki a \_\_\_\_\_ . (grandparent)

Keiki a \_\_\_\_\_ (great-grandparent)

a me \_\_\_\_\_ .(great grandparent)



# KU'U MO'OKŪ'AUHAU

**Daniela  
Kekino  
Kahakalau**

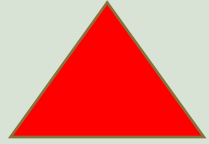

=

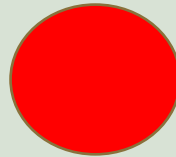

**Keao  
Opupele**

**William  
Keahonui  
Kahakalau**

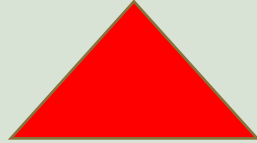

=



**Irene  
Dow**

**Robert A.  
Kahakalau**

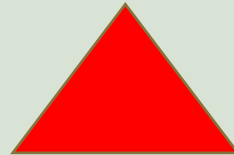

=



**Frieda B.  
Schmidt**

**Kū Hinahinakūikahakai Kahakalau**





## HO‘OLAUNA (Handout)

Introduce yourself by sharing your full name, your birthplace, your island and 4 more places that have shaped you into who you are today.

ALOHA

‘O _____ ko‘u inoa.	<i>My name is _____.</i>
‘O _____ ku‘u one hānau.	<i>My birthplace is _____.</i>
‘O _____ ku‘u mokupuni.	<i>My island is _____.</i>
‘O _____ ku‘u .....	<i>My ..... is _____.</i>

mauna, ‘āina, ahupua‘a, kai, pu‘u, wailele, awāwa, .....

# KU‘U MO‘OKŪ‘AUHAU

‘O (w)au ‘o \_\_\_\_\_ . (name)

Keiki a \_\_\_\_\_ . (parent)

Keiki a \_\_\_\_\_ . (grandparent)

Keiki a \_\_\_\_\_ (great-grandparent)

a me \_\_\_\_\_ (great grandparent)



# KAHOOT



KŪ-A-KANAKA

[www.kuakanaka.com](http://www.kuakanaka.com)

**When Natives Thrive Everyone Benefits**

HE AHA KA HANA?



# VOCABULARY REVIEW

QUIZLET LIVE





LOCATION: Showing where something/somebody is.

EIA shows location when something is HERE.

EX: Eia ka pahi.

Eia nā hua moa.

Eia ‘o Pōlani.

Grab four (4) items from your kitchen and share:

Eia ke/ka/nā \_\_\_\_\_.

AIA shows Location when something is THERE

**Aia** ke/ka/nā/‘o \_\_\_\_\_ **ma** ke/ka/nā \_\_\_\_\_.

Example:

**Aia** ka liliko‘i **ma** ka pola. Lit: There is the passionfruit in the bowl.

The passionfruit is in the bowl.

**Aia** ke kalo **ma** ka lo‘i. The taro is in the taro patch.

**Aia** nā hua‘ai **ma** ke kinika. The fruits are in the sink.

**Aia** ‘o Pōlani **ma** Maui. Pōlani is in Maui.



Aia \_\_\_\_\_ ma/i \_\_\_\_\_.

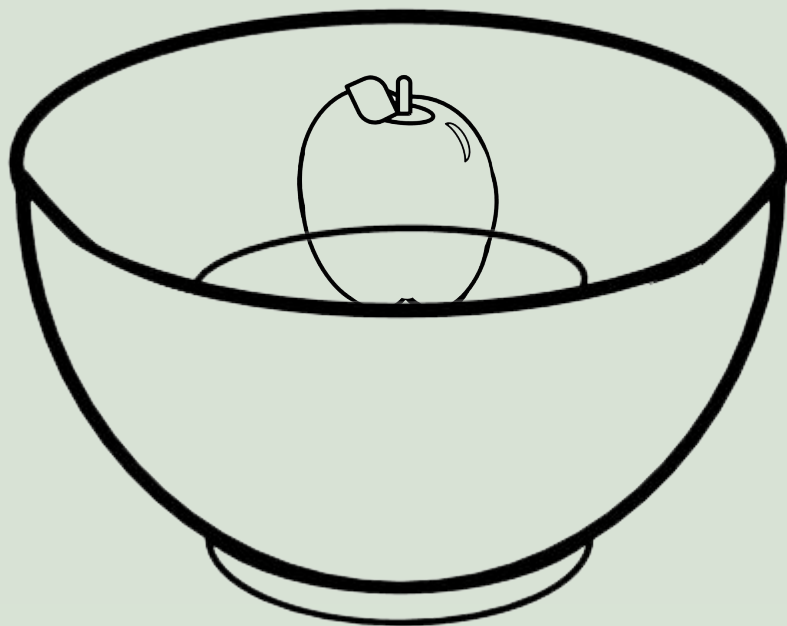

Aia \_\_\_\_\_ ma \_\_\_\_\_.

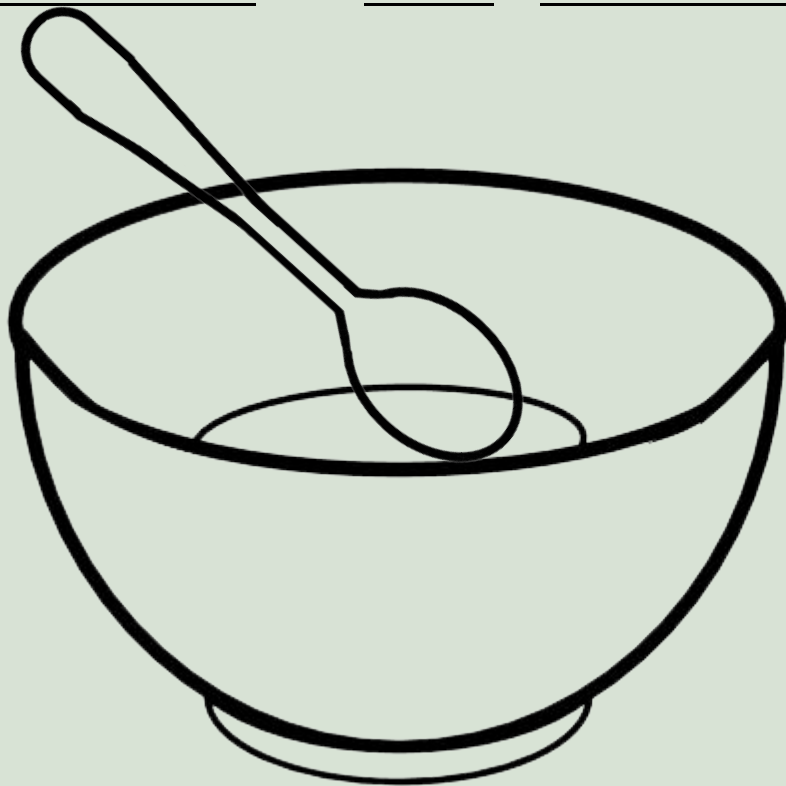

Aia \_\_\_\_\_ ma \_\_\_\_\_.





Aia \_\_\_\_\_ a me \_\_\_\_\_ ma \_\_\_\_\_.

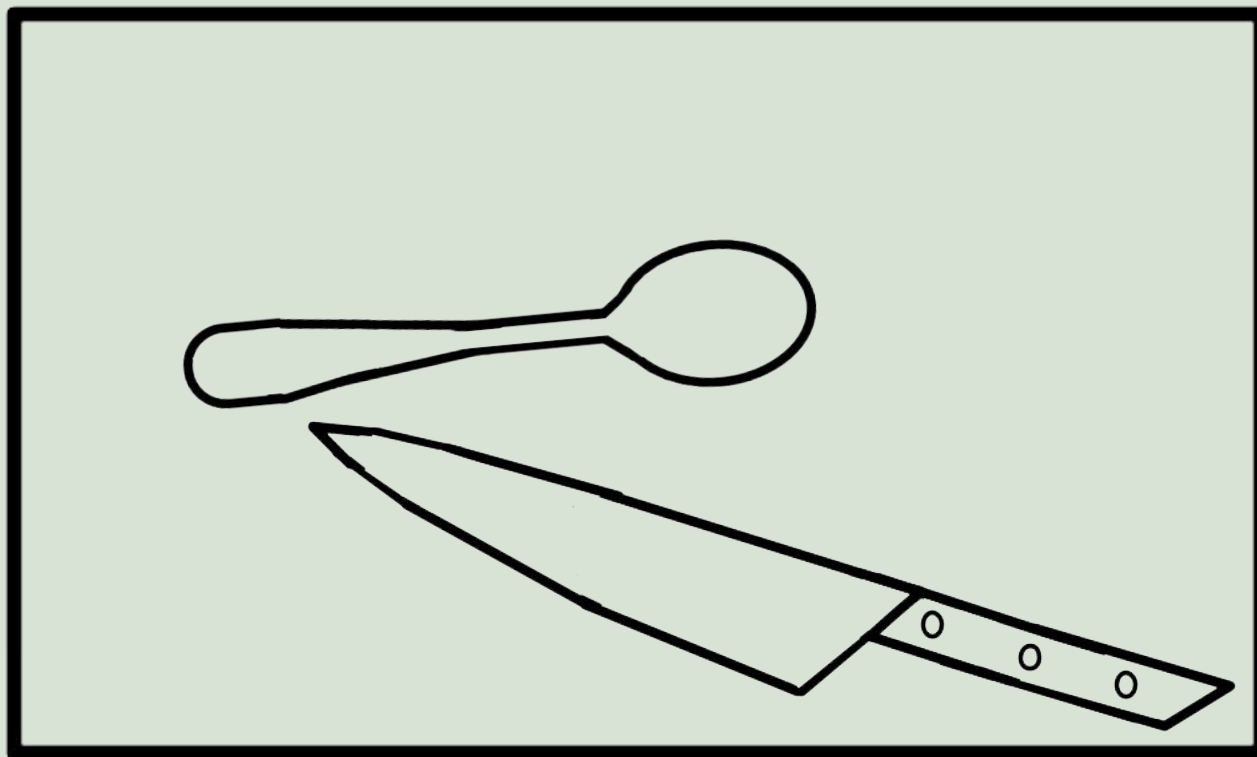

Aia \_\_\_\_\_ ma \_\_\_\_\_.

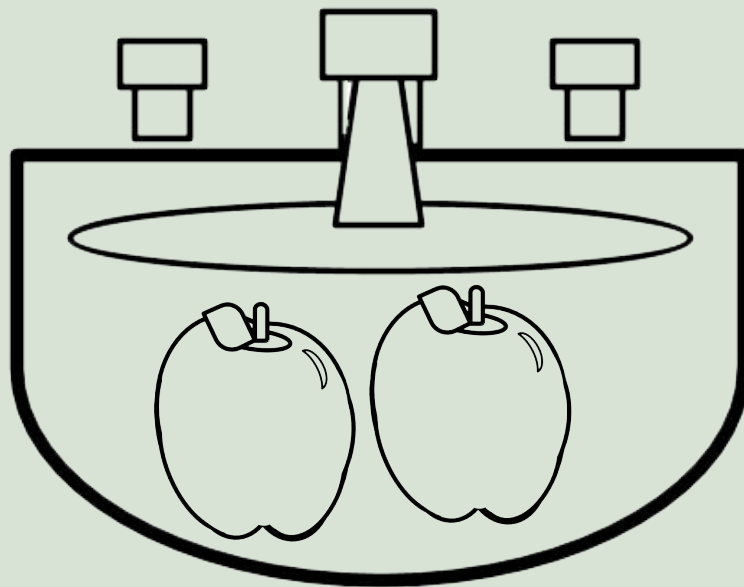

Aia \_\_\_\_\_ ma \_\_\_\_\_.

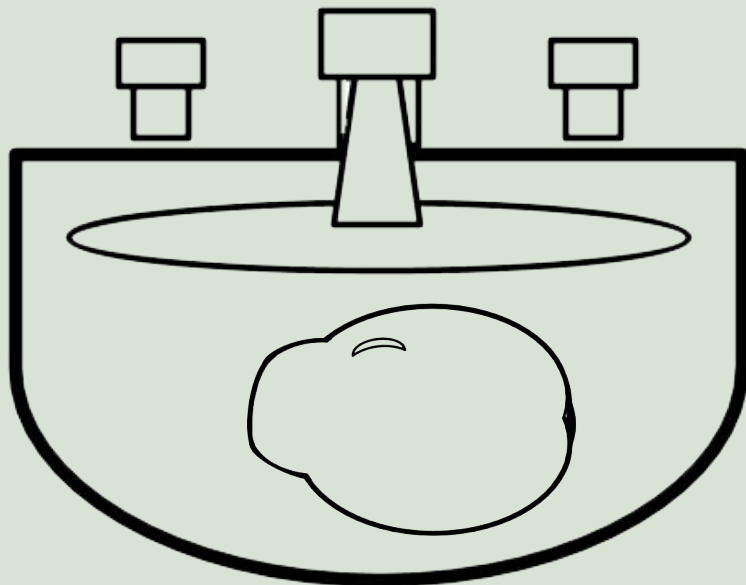

Aia \_\_\_\_\_ ma \_\_\_\_\_.

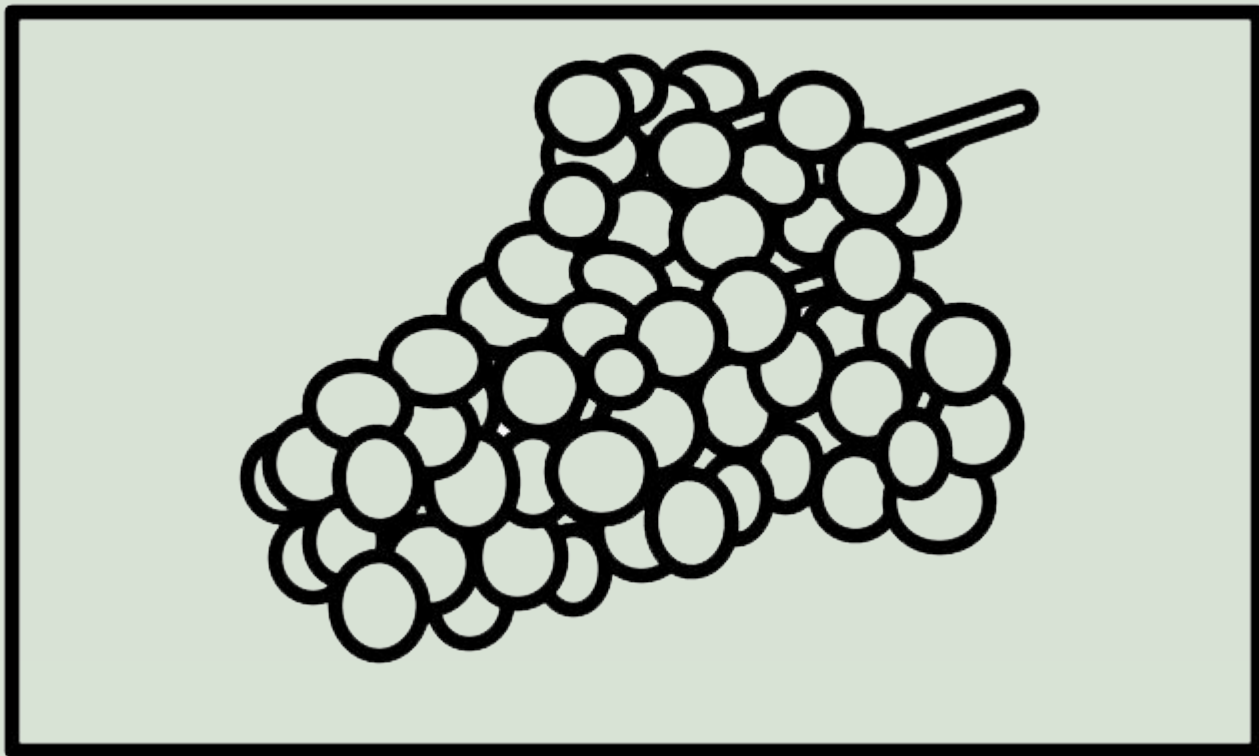

**KE AO NANI (THE BEAUTIFUL WORLD) by Mary Kawena Pukui**

**I luna la i luna, nā manu o ka lewa**      Up above, above, birds of the heavens

**I lalo la i lalo, nā pua o ka honua**      Below, below, flowers of the earth

**I uka la i uka, nā ulu ‘lā‘au**      In the mountains, mountains, the forests

**I kai la i kai, nā i`a o ka moana**      In the sea, the sea, fishes of the ocean

**Ha`ina mai ka puana, a he nani ke ao nei**      Tell the refrain of the beautiful world

**He inoa no kamali`i**      In the name of children

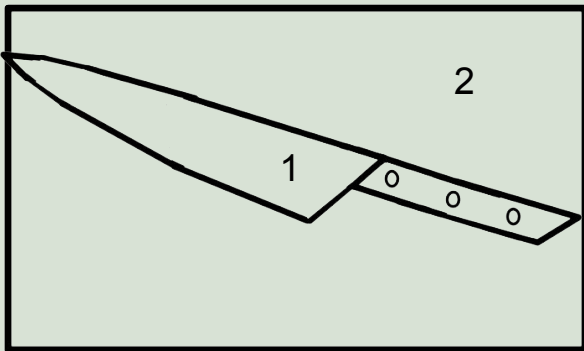

**Aia ka pahi ma *luna* o ka papa'oki.**

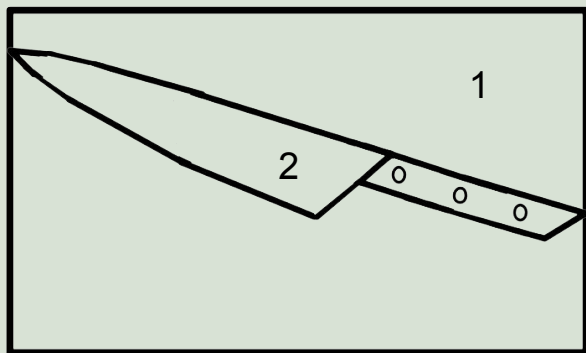

**Aia ka papa'oki ma *lalo* o ka pahi.**



**Aia** ke kupunahine ma *uka* o  
ke kupunakāne.

**Aia** ke kāne ma *kai* o ka  
wahine.

**Aia** nā kūpuna ma *uka* o ka  
wahine.





**Aia** ka waiūpaka **ma** *mua* **o** nā hua moa.

**Aia** nā hua moa **ma** *hope* **o** ka waiūpaka.

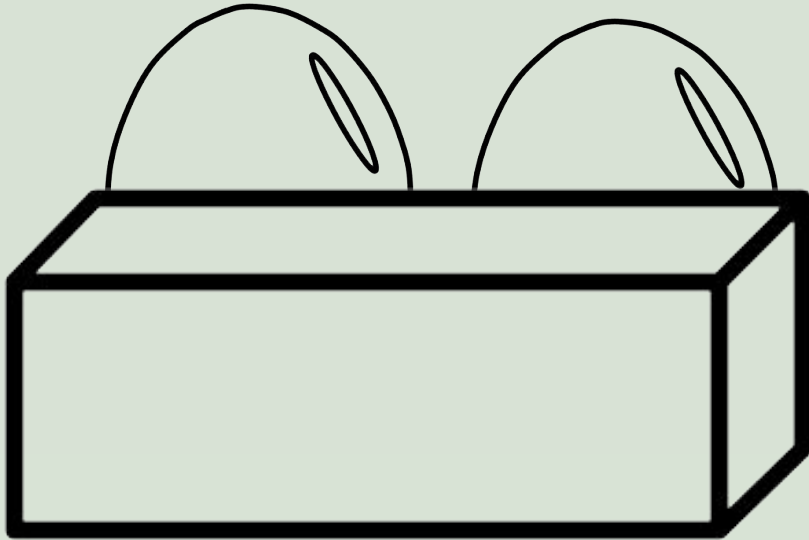

**Aia ka moa ma *waho* o ka pā palai.**



**Aia ka moa i *loko* o ka pā pālai.**

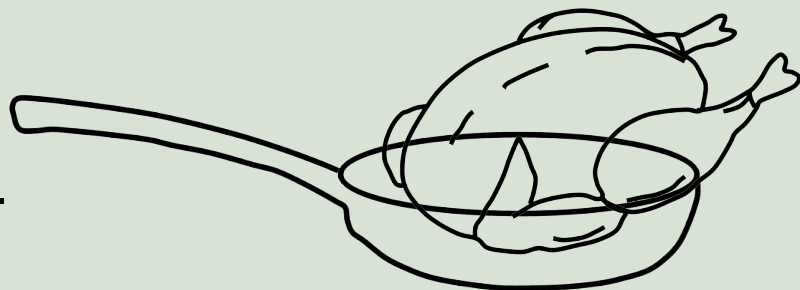

**Aia** nā na‘aukake **ma** *waena* o nā pola.

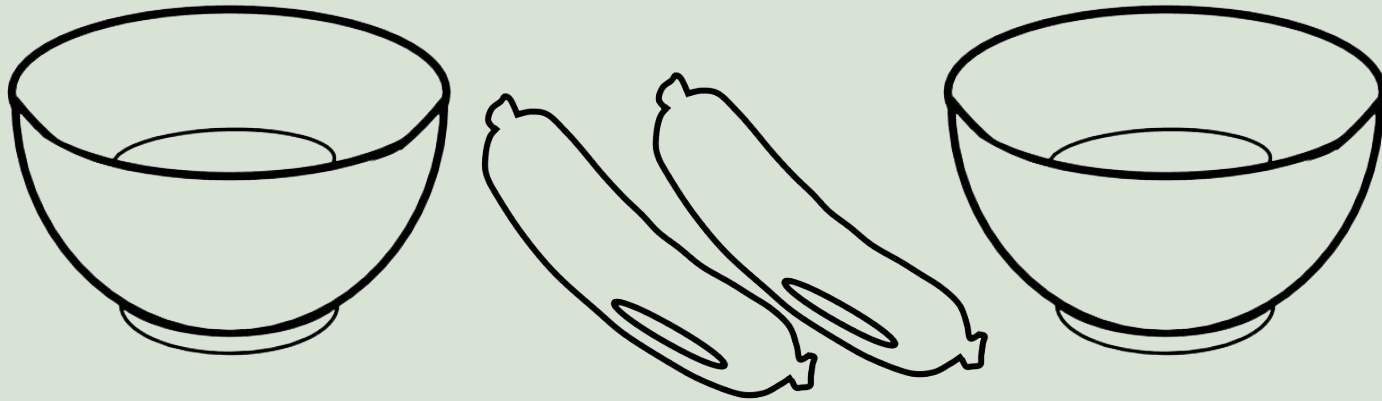

# NĀ HUA ‘ŌLELO HOU (VOCABULARY WORDS)

\_\_\_ ‘aina kakahiaka

\_\_\_ pahuhau

\_\_\_ kapuahi

\_\_\_ ‘ūlau

\_\_\_ pā pālai

\_\_\_ kāwele pepa

\_\_\_ ‘apu

\_\_\_ kōpa‘a

\_\_\_ koiū

\_\_\_ ‘aila

\_\_\_ na‘aukake

\_\_\_ wai‘alani

\_\_\_ huamoā

\_\_\_ waiūpaka

\_\_\_ palaoa

‘ākau

hema

ho‘ā

ho‘opio

kau

‘AINA KAKAHIKA

‘AINA AWAKEA

‘AINA AHIAHI



# HO‘OMĀKAUKAU HŌ‘IKE



## HA‘AWINA HALE (HOMEWORK ASSIGNMENT REVIEW)

- Study BREAKFAST vocabulary using Quizlet and App.
- Watch BREAKFAST video and try to figure out what is going on.
- Watch HO‘ONANI video and practice mele.
- Brainstorm what you will prepare for hō‘ike.
- Continue to watch I OLA NŌ KE KINO video and practice pule.
- Review ALOHA E and MAHALO E and be able to chant it as ‘ohana.
- Do your HO‘OLAUNA to 5 NEW people until next class.



# HO‘OMĀKAUKAU (PREPARE)

- na‘aukake
- hua moa (2 no 1 kanaka)
- palaoa
- mea inu
- ‘aila
- pa‘akai
- pepa
- waiūpaka
- pā pālai
- ‘ūlau
- kāwele pepa
- ‘apu
- pā
- ‘ō
- pahi
- papa ‘oki





# HE MAU NĪNAU?



# **WEBPAGE**

**[www.kuakanaka.com/hoomakaukai](http://www.kuakanaka.com/hoomakaukai)**

**PW: aloha1234**



## **MAHALO E** (Gratitude Chant)

*Nā Nālei and Kū Kahakalau*

**Mahalo e**

*Gratitude*

**Mahalo e ka lehulehu**

*Gratitude to the multitudes*

**Mahalo e nā mākua**

*Gratitude adults*

**Mahalo e nā kūpuna**

*Gratitude elders*

**Mahalo e nā ali'i o Hawai'i**

*Gratitude to the chiefs of Hawai'i*

**Mahalo e nā 'aumākua**

*Gratitude to the ancestors*

**Mahalo e nā akua**

*Gratitude to the deities*

**Mahalo e**

*Gratitude*





A hui hou kākou i kēia pule a‘e.



For more information about Kū-A-Kanaka LLC  
products and services contact:

**Kū Kahakalau, Ph.D.**  
KŪ-A-KANAKA LLC

**[ku@kuakanaka.com](mailto:ku@kuakanaka.com)**

**(808) 315-8157**

**[www.kuakanaka.com](http://www.kuakanaka.com)**

